

TOUCH PANEL CONTROLLER**Delivery Specifications****Model Name: AHL-120N8**

* The contents of specifications are subject to change without prior notice for product improvements.

The export of this product from Japan is regulated by the Japanese government. The export of this product may be prohibited without governmental license. To export or re-export of this product from a country other than Japan may also be prohibited without a license from that country. Please call a GUNZE LIMITED sales representative.

GUNZE LIMITED**ELECTRONIC COMPONENTS DIVISION**

Electronic Components Division: 10, Shindo, Amarube-cho,
Kameoka city, Kyoto (621-0806), Japan

Osaka Sales Section: Hanahara 6th Building, 6-8-31, Nishinakajima,
Yodogawa-ku, Osaka (532-0011), Japan
TEL +81-6-6303-6220

Tokyo Sales Section: GUNZE Nihonbashi Building, 2-10-4, Nihonbashi,
Chuoh-ku, Tokyo (103-0027), Japan
TEL +81-3-3276-8717

Approved by: _____

Checked by: _____

Checked by: _____

Staff Responsible: _____

Date of Revision	Indication for Revision	Revised Contents	Checked by
			Staff Responsible
Oct. 10, 2007	Preliminary edition		T. Kato
Dec. 17, 2007	1 st edition	5.EEPROM Connection Added 'more than 25ms' description. 10.Serial Interface (1)Outline Added Windows Vista. (5)Response speed Added '7msec(min.)' description. (7)Command System Added 'EA' command. 17.Appendix Corrected '10bit' to '12bit'	T. Kato

 **Precautions**

1. Avoid using this panel for applications that may affect people's lives, such as medical equipment, space equipment, aircraft, submarine repeater and other equipment for which extremely high reliability is required.

2. If you are planning to use this panel for control or security system in transport equipment (train, automobile and vessel or the like), always contact our sales service center in advance.

The quality level of this product is limited to general applications. (Computer, OA equipment, FA equipment, communication equipment, measuring equipment, AV equipment, etc.)

3. Do not ever remodel or recompose our products. It may cause problems and breakdown.

* The copy right of this specification belongs to GUNZE LIMITED, and all rights are reserved.

* The contents of this specification may be changed without notice.

* Trademarks in this specification:

PC/AT is a registered trademark of International Business Machine Corporation (IBM).

Windows XP, Windows 2000 and Windows Me are registered trademarks of U.S. Microsoft company.

The others, company's name and product's name, are also registered trademarks of each company.

CONTENTS

1. Outline	6
2. Features	6
(1) Power supply	6
(2) Clock frequency	6
(3) Electrical resolution	6
(4) Output system	6
(5) Output datarate	6
(6) Output mode	6
(7) Applicable touch panel	6
(8) External shape	6
(9) Environmental characteristics	6
3. Terminal Arrangement Drawing	7
4. Terminal Function	7
5. EEPROM Connection	8
6. Electrical Characteristics.....	8
(1) Absolute maximum rating	8
(2) DC characteristics - Supply voltage	8
(3) DC characteristics - Power consumption	9
(4) DC characteristics	9
(5) USB module specifications	9
(6)AC(Timing)requirements	10
(7)USB Timing requirements	10
(8) A/D converter characteristics	10
7. Settings	11
(1) Outline	11
(2) Setting	11
(3)Interface selection	11
(4) Working Mode selection	11
8.Output Mode	11
9. USB Interface	12
(1) Outline	12
(2) Basic specifications	12
(3) Data (Response to IN token) format	12
1) At touch or release:.....	12
2) When no touch panel is touched:.....	12
(4) Descriptor	13
1) Device Descriptor	13
2) Configuration Descriptor	13
3) Interface Descriptor	14
4) HID Descriptor	14
5) Endpoint Descriptor	14
6) String Descriptor	15
7) Report Descriptor	15

10. Serial Interface.....	16
(1) Outline	16
(2) Output mode	16
(3) Communication format	16
(4) Text format	16
(5) Response speed	17
(6) Output rate	17
(7) Command System	18
(8) Output pattern when the transmission stop and transmission restart commands were received	19
(9)About Plug and Play	20
11. Other Functions	21
(1) Reset	21
(2) Buzzer	21
(3) Calibration	21
(a) Auto calibration.....	21
(b) User calibration	22
12. Outline Drawing	23
13. Peripheral Circuit Example.....	24
14. Mounting Conditions	25
15. Operating Precautions	26
16. Warranty Period and Warranty Range.....	26
(1) Warranty period	26
(2) Warranty range	26
17. Appendix.....	27
(a) 4-wire touch panel	27
(b) 8-wire touch panel	27

1. Outline

The AHL-120N8 is a controller to detect the touching position on the touch panel. Even if an unstable data (voltage value) generated when the touch panel was lightly depressed and noise arising due to operating environment are inputted to the AHL-120N8, internal filtering (firmware) is carried out; it is, therefore, possible to detect the pushing pressure position with high precision.

The communication system contains serial (Asynchronous mode) and USB. Where the serial interface is used, direct connection to the COM port of a personal computer or the like is possible by connecting the EIA-232D (RS-232C) transceiver. In the case of USB interface specification, direct connection to the USB port of a personal computer, etc. is possible.

For the circuit in the touch panel driving part among the AHL-120N8 peripheral circuits, use the GUNZE recommendable circuit. (Refer to "13. Peripheral Circuit Example".)

2. Features

(1) Power supply

3.0 to 5.5V

(2) Clock frequency

20MHz

(3) Electrical resolution

10 bits (1,024 × 1,024)

NOTE) This numerical value is the electrical resolution of AHL-120N8. The electrical resolution in the touch panel key area is lower than this numerical value, which differs among the touch panels.

In addition, the data which are really output is 12bits resolution (4,096 × 4,096).

(4) Output system

- Serial (Asynchronous mode)
- USB (Universal Serial Bus)

(5) Output datarate

- 87 cps (Serial interface)

NOTE) Under the following communication conditions:

Communication speed	:	9,600 bps
Parity	:	None
Data length	:	8 bits
Stop bit length	:	1 bit

- 100 cps (USB interface)

* cps: Co-ordinate point Per Second

(6) Output mode

- Continuous (The coordinate data is transmitted while the touch panel is being touched.)
- Make (The coordinate data is transmitted when the touch panel is touched.)
- Make & break (The coordinate data is transmitted when the touch panel is touched and released.)

(7) Applicable touch panel

- GUNZE's 4- & 8-wire conductive layer type analog touch panel

(8) External shape

28-pin QFN (6 × 6 × 0.9 mm)

(9) Environmental characteristics

- RoHS compliant

3. Terminal Arrangement Drawing

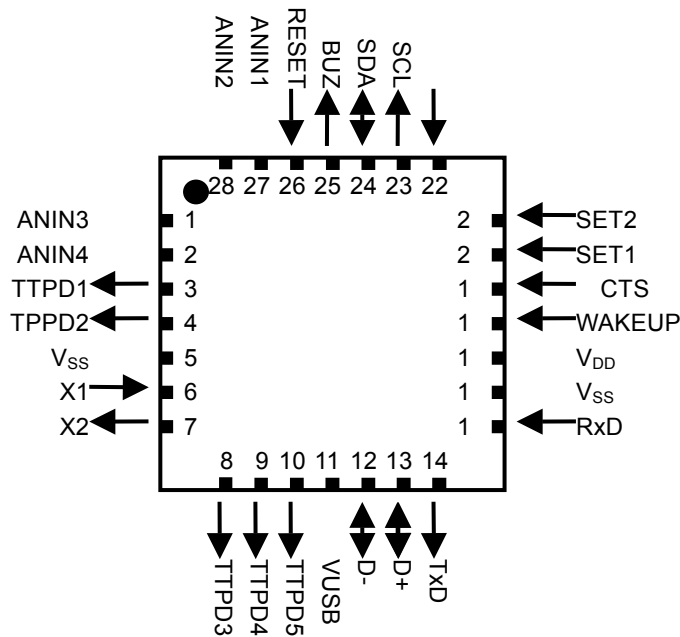

4. Terminal Function

Pin No.	Terminal Name	Input/Output	Function	Pin No.	Terminal Name	Input/Output	Function
26	RESET	I	External reset input	18	WAKEUP	I	Release USB suspend
27	ANIN1		Touch panel input	19	CTS	I	Serial PnP trigger input *1
28	ANIN2		Touch panel input	20	SET1	I	I/F selection *1
1	ANIN3		Touch panel input	21	SET2	I	Working Mode selection *1
2	ANIN4		Touch panel input	22	ROMCLR	I	EEPROM data reset*1
3	TTPD1	O	Touch panel control	23	SCL	O	EEPROM clock output *1
4	TTPD2	O	Touch panel control	24	SDA	I/O	EEPROM date Input/Output *1
8	TTPD3	O	Touch panel control	25	BUZ	O	Buzzer output
9	TTPD4	O	Touch panel control	6	X1	I	Clock input (connect oscillator)
10	TTPD5	O	Touch panel control	7	X2	O	Clock output (connect oscillator)
12	D-	I/O	USBdata sending & receiving	11	VUSB		Power supply for USB
13	D+	I/O	USBdata sending & receiving	17	V _{DD}		Power supply
14	TxD	O	serial data sending	5,16	V _{SS}		Ground
15	RxD	I	serial data receiving				

*1: Please do pull-up 19-24 pins to VDD through 10kΩ resistance.

5. EEPROM Connection

By connecting the serial EEPROM (Microchip 24LC00 or its equivalent) of the I²C system to the AHL-120N8, setting value can be saved.

When ROMCLR(22pin) become the High level after keeping the Low level more than 25ms, the setting contents are initialized. The data to save are really 8byte.

The connection is as shown in the figure below.

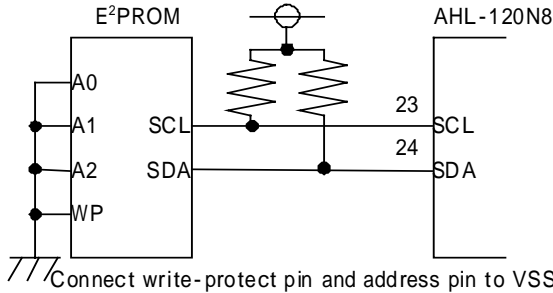

* When the EEPROM is not used, AHL-120N8 of 23,24-pin should be pull-up through 10k resistance.

6. Electrical Characteristics

(1) Absolute maximum rating

Operating ambient temperature	-40 ~ 85
Storage temperature	-65 ~ 150
Input voltage (besides V _{DD})	-0.3V ~ (V _{DD} +0.3V)
Input voltage (V _{DD})	-0.3V ~ 7.5V
Power consumption	1.0W
Max current (inflow V _{SS})	300mA
Max current (outflow V _{DD})	250mA
Input current clamp (V _I < 0 or V _I > V _{DD})	± 20mA
Output current clamp (V _O < 0 or V _O > V _{DD})	± 20mA
Max output sink current (each I/O pins)	25mA
Max output current source (each I/O pins)	25mA
Max sink current (all I/O pins)	200mA
Max source current (all I/O pins)	200mA

NOTE) where the unit was used with the absolute maximum rating exceeded, permanent breakdown may be caused to the AHL-120N8. In normal operation, it is desirable to use this unit under the recommended operating conditions, and if these conditions were exceeded, AHL-120N8 reliability will be adversely affected.

(2) DC characteristics - Supply voltage

(T_A=-40 ~ 85 °C)

Item	Symbol	MIN	STD	MAX	Unit	Remarks
Supply Voltage	V _{DD}	3.0	-	5.5	V	
V _{DD} Start Voltage	V _{POR}	-	-	0.7	V	Condition to carry out power on reset
V _{DD} Rise Rate	S _{VDD}	0.05	-	-	V/ms	Condition to carry out power on reset
Brown-out Reset Voltage	V _{BOR}	2.65	2.79	2.93	V	surely

(3) DC characteristics - Power consumption
($V_{DD}=5.0V$)

Item	Symbol	MIN	STD	MAX	Unit	Remarks
Supply Current	I_{DD}	$T_A=-40 \sim 85$	25	60	mA	
Power-Down Current	I_{PD}	$T_A=-40$	0.1	19	μA	USB Suspend state
		$T_A=25$	0.1	2.0	μA	
		$T_A=85$	2.5	15	μA	

(4) DC characteristics
($T_A=-40 \sim 85$)

Item	Symbol	MIN	STD	MAX	Unit	Remarks
Input Low Voltage	V_{IL}	$V_{DD} < 4.5V$	V_{SS}	$0.15V_{DD}$	V	RxD, CTS, WAKEUP, SET1
		$4.5V < V_{DD} < 5.5V$	-	0.8	V	SET2, ROMCLR, SDA
			V_{SS}	$0.2V_{DD}$	V	RESET
			V_{SS}	$0.3V_{DD}$	V	X1
	V_{ILU}	$V_{DD} = 4.35V$ USB Suspended	-	0.8	V	D+, D-
Input High Voltage	V_{IH}	$V_{DD} < 4.5V$	$0.25V_{DD}$	V_{DD}	V	RxD, CTS, WAKEUP, SET1
		$4.5V < V_{DD} < 5.5V$	2.0	V_{DD}	V	SET2, ROMCLR, SDA
			$0.8V_{DD}$	V_{DD}	V	RESET
			$0.7V_{DD}$	V_{DD}	V	X1
	V_{IHU}	$V_{DD} = 4.35V$ USB Suspended	2.4	-	V	D+, D-
Output Low Voltage	V_{OL}	$I_{OL} = 8.5mA$, $V_{DD} = 4.5V$	-	0.6	V	TTPD1 ~ 5, TxD, BUZ, SCL, SDA
	V_{OLU}	$V_{DD} = 4.35V$ USB Suspended	-	0.3	V	D+, D-
Output High Voltage	V_{OH}	$I_{OL} = -3.0mA$, $V_{DD} = 4.5V$	$V_{DD} - 0.7$	-	V	TTPD1 ~ 5, TxD, BUZ, SCL, SDA
	V_{OHU}	$V_{DD} = 4.35V$ USB Suspended	2.8	3.6	V	D+, D-

(5) USB module specifications
($T_A=-40 \sim 85$)

Item	Symbol	MIN	STD	MAX	Unit	Remarks
USB Voltage	V_{USB}	3.0	-	3.6	V	
Input Leakage on pin	I_{IL}	-	-	± 1	μA	V_{SS} V_{PAD} V_{DD} pin at high impedance
Input Low Voltage for USB Buffer	V_{ILUSB}	-	-	0.8	V	
Input High Voltage for USB Buffer	V_{IHUSB}	2.0	-	-	V	
Crossover Voltage	V_{CRS}	1.3	-	2.0	V	
Differential Input Sensitivity	V_{DIFS}	-	-	0.2	V	
Differential Common Mode Range	V_{CM}	0.8	-	2.5	V	
Driver Output Impedance	Z_{OUT}	28	-	44		
Voltage Output Low	V_{OL}	0.0	-	0.3	V	Pull-up through 15 K Ω
Voltage Output High	V_{OH}	2.8	-	3.6	V	Pull-down through 1.5 K Ω

(6)AC(Timing)requirements
($T_A = -40 \sim 85$)

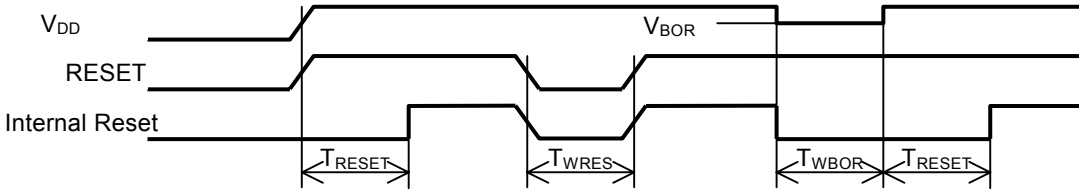

Item	Symbol	MIN	STD	MAX	Unit	Remarks
Low Reset Input Pulse Width	T _{WRES}	2	-	-	us	
Brown-out Reset Pulse Width	T _{WBOR}	2	-	-	us	V _{DD} V _{BOR}
Oscillator Start-up Timer Period	T _{RESET}	67.5	-	77	ms	

(7)USB Timing requirements

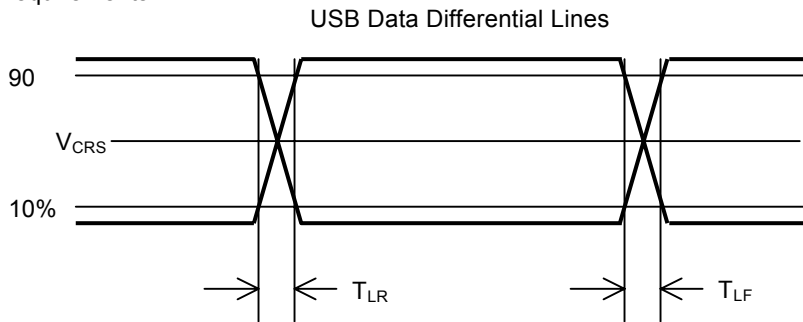

Item	Symbol	MIN	STD	MAX	Unit	Remarks
Transition Rise Time	T _{LR}	75		300	ns	C _L 200 ~ 600pF
Transition Fall Time	T _{LF}	75		300	ns	C _L 200 ~ 600pF
Rise/Fall Time Matching	T _{LRLF}	80		125	%	

(8) A/D converter characteristics
(V_{DD} = 3.0 ~ 5.5V)

Item	MIN	STD	MAX	Unit
Resolution	-	-	10	bit
Integral Linearity Error	-	-	< ± 1	LSB
Differential Linearity Error	-	-	< ± 1	LSB
Offset Error	-	-	< ± 1.5	LSB
Gain Error	-	-	< ± 1	LSB

NOTE) Value of upper list is a characteristic of A./D converter in itself of AHL-120N8.The coordinate data which are output by AHL-120N8 revise voltage of reference electrode and convert 12bit by internal process. Therefore value of upper list is not just applied.

7. Settings

(1) Outline

Mode of operation is determined by connecting specified pin to V_{DD} or V_{SS}.

(2) Setting

Pins(#)	Function	Connect to V _{DD}	Connect to V _{SS}
SET1(20)	I/F selection	USB	Serial
SET2(21)	Working Mode selection	AHL Original	WHQL Mode

(3)Interface selection

Interface Mode is defined by the logical level of Pin -SET1 (20).

(4) Working Mode selection

Working Mode is defined by the logical level of Pin –SET2 (21).

In AHL Original mode, Both USB and Serial can use conventional TTP device driver (U-TP,TPDD).

WHQL Mode has some characteristics described below.

-USB interface: Based on HID(Human Interface Device)

-Serial interface: Correspond to PnP(Plug and Play)

So, it's possible to use new TTP device driver GzTP which has obtained Microsoft LOGO.

8.Output Mode

- Continuous mode

The positional data is continuously outputted while the touch panel is being touched. When your finger or pen was released from the touch panel, only one data in the release position is outputted. When it is not touched, no data is outputted.

- Make mode

When the touch panel was touched, only one initial position data is outputted. Unless the touch panel is touched after your finger or pen was released from the touch panel, the next data is not outputted.

- Make & Break mode

When the touch panel was touched, only one initial position data is outputted. When your finger or pen was released from the touch panel, only one release position data is outputted.

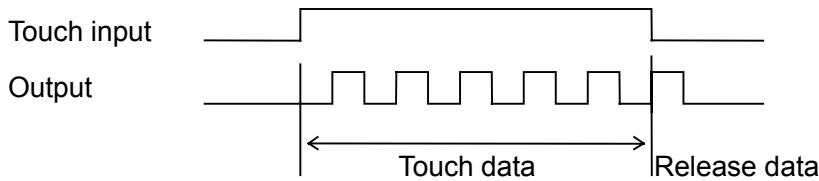

9. USB Interface

(1) Outline

The AHL-120N8 has the built-in USB (Universal Serial Bus) interface, by which the touch position data can be obtained via the USB port of a personal computer. Also, a device driver for mouse emulation is arranged.

The product name of the device driver is TPDD, U-TD and WHQL.

TPDD supports Windows Me, Windows 2000 and Windows XP, as AHL Original mode.

GZTP PACK supports Windows 2000 and Windows XP as WHQL mode.

(2) Basic specifications

Transfer speed : 1.5 Mbps

Transfer format : Interrupt transfer

Transfer interval : 10 ms

(3) Data (Response to IN token) format

1) At touch or release:

- AHL Original mode

	bit7	bit6	bit5	bit4	bit3	bit2	bit1	bit0
1st byte	1	0	T/R_(*1)	X11	X10	X9	X8	X7
2nd byte	0	0	0	Y11	Y10	Y9	Y8	Y7
3rd byte	0	X6	X5	X4	X3	X2	X1	X0
4th byte	0	Y6	Y5	Y4	Y3	Y2	Y1	Y0

(*1) "1" at touch and "0" at release.

-WHQL mode, based on HID

	bit7	bit6	bit5	bit4	bit3	bit2	bit1	bit0
1st byte	0	0	0	0	0	0	0	T/R_
2nd byte	X7	X6	X5	X4	X3	X2	X1	X0
3rd byte	0	0	0	0	0	0	X9	X8
4th byte	Y7	Y6	Y5	Y4	Y3	Y2	Y1	Y0
5th byte	0	0	0	0	0	0	Y9	Y8

First data after "touched" is "0", after second data is "1", when released then return to "0"

2) When no touch panel is touched:

NAK handshaking is returned.

(4) Descriptor

1) Device Descriptor

-for AHL Original mode

Field	Value	Description
bLength	12H	
bDescriptorType	01H	Device
bcdUSB	0200H	USB2.0
bDeviceClass	FFH	Vendor Specific
bDeviceSubClass	FFH	
bDeviceProtocol	FFH	Vendor Specific
bMaxPacketSize0	08H	
idVendor	0637H	
idProduct	0001H	
bcdDevice	0100H	
iManufacturer	01H	
iProduct	02H	
iSerialNumber	00H	No String Descriptor
bNumConfigurations	01H	

- for WHQL mode based on HID

Field	Value	Description
bLength	12H	
bDescriptorType	01H	Device
bcdUSB	0200H	USB2.0
bDeviceClass	00H	
bDeviceSubClass	00H	
bDeviceProtocol	00H	
bMaxPacketSize0	08H	
idVendor	0637H	
idProduct	0004H	
bcdDevice	0100H	
iManufacturer	01H	
iProduct	02H	
iSerialNumber	00H	No String Descriptor
bNumConfigurations	01H	

2) Configuration Descriptor

- for AHL Original mode

Field	Value	Description
bLength	09H	
bDescriptorType	02H	Configuration
wTotalLength	0019H	
bNumInterfaces	01H	
bConfigurationValue	01H	
iConfiguration	00H	No String Descriptor
bmAttributes	10100000B	Bus-Powered,Remote WakeUp
MaxPower	32H	100mA

- for WHQL mode based on HID

Field	Value	Description
bLength	09H	
bDescriptorType	02H	Configuration
wTotalLength	0022H	
bNumInterfaces	01H	
bConfigurationValue	01H	
iConfiguration	00H	No String Descriptor
bmAttributes	10100000B	Bus-Powered,Remote WakeUp
MaxPower	32H	100mA

3) Interface Descriptor

- for AHL Original mode

Field	Value	Description
bLength	09H	
bDescriptorType	04H	Interface
bInterfaceNumber	00H	
bAlternateSetting	00H	
bNumEndpoints	01H	
bInterfaceClass	FFH	Vendor Specific
bInterfaceSubClass	FFH	Vendor Specific
bInterfaceProtocol	FFH	Vendor Specific
iInterface	00H	No String Descriptor

- for WHQL mode based on HID

Field	Value	Description
bLength	09H	
bDescriptorType	04H	Interface
bInterfaceNumber	00H	
bAlternateSetting	00H	
bNumEndpoints	01H	
bInterfaceClass	03H	HID
bInterfaceSubClass	01H	Boot
bInterfaceProtocol	02H	Mouse
iInterface	00H	No String Descriptor

4) HID Descriptor

- for WHQL mode based on HID only

Field	Value	Description
bLength	09H	
bDescriptorType	21H	Interface
bcdHID	0110H	HID 1.1
bCountryCode	00H	Not Localized
bNumDescriptors	01H	
bDescriptorType	22H	Report
wDescriptorLength	003AH	

5) Endpoint Descriptor

-for both AHL Original mode and WHQL mode based on HID

Field	Value	Description
bLength	07H	
bDescriptorType	05H	Endpoint
bEndpointAddress	81H	Endpoint1, IN
bmAttributes	00000011B	Interrupt Transaction
wMaxPacketSize	0008H	
bInterval	0AH	10msec

6) String Descriptor

-for both AHL Original mode and WHQL mode based on HID

Field	Value	Description
bLength	04H	
bDescriptorType	03H	String
wLangID	0409H	English
[Index1]		
Field	Value	Description
BLength	0CH	
BDescriptorType	03H	String
BString	"GUNZE"(Unicode)	
[Index2]		
Field	Value	Description
BLength	38H	
BDescriptorType	03H	String
BString	"GUNZE Touch Panel(4/8 Wire)"(Unicode)	

7) Report Descriptor

-for WHQL mode based on HID only

Value	Description
05H, 01H	USAGE_PAGE (Generic Desktop)
09H, 02H	USAGE (Mouse)
A1H, 01H	COLLECTION (Application)
09H, 01H	USAGE (Pointer)
A1H, 00H	COLLECTION (Physical)
05H, 09H	USAGE_PAGE (Button)
19H, 01H	USAGE_MINIMUM (Button 1)
29H, 03H	USAGE_MAXIMUM (Button 3)
15H, 00H	LOGICAL_MINIMUM (0)
25H, 01H	LOGICAL_MAXIMUM (1)
95H, 03H	REPORT_COUNT (3)
75H, 01H	REPORT_SIZE (1)
81H, 02H	INPUT (Data,Var,Abs)
95H, 01H	REPORT_COUNT (1)
75H, 05H	REPORT_SIZE (5)
81H, 01H	INPUT (Cnst,Ary,Abs)
05H, 01H	USAGE_PAGE (Generic Desktop)
09H, 30H	USAGE (X)
09H, 31H	USAGE (Y)
16H, 00H, 00H	LOGICAL_MINIMUM (0)
26H, FFH, 0FH	LOGICAL_MAXIMUM (4095)
36H, 00H, 00H	PHYSICAL_MINIMUM (0)
46H, FFH, 0FH	PHYSICAL_MAXIMUM (4095)
95H, 02H	REPORT_COUNT (2)
75H, 10H	REPORT_SIZE (16)
81H, 02H	INPUT (Data,Var,Abs)
C0H	END_COLLECTION
C0H	END_COLLECTION

10. Serial Interface

(1) Outline

Using asynchronous mode serial, touch position data and command communication can be carried out. By connecting EIA-232D (RS-323C) transceiver, direct connection to the COM port of a personal computer, etc. is possible. Also available is the device driver for mouse emulation. By using this unit, the touch panel can be used in place of the mouse.

TPDD supports Windows Me, Windows 2000, Windows XP and Windows Vista, as AHL Original mode.

GZTP PACK supports Windows XP and Windows Vista as WHQL mode.

*As for other device drivers released before, please contact us without hesitate.

(2) Output mode

Continuous, Make, Make & Break

Note) The underline is the default setting. Where EEPROM is connected externally, the changed communication mode can be saved.

(3) Communication format

- Communication speed : 1200/ 2400 / 4800 / 9600 / 19200/ 38400 bps
- Data length : 8 bits
- Parity : None
- Stop bit : 1 bit
- Flow control : Software (Xon / Xoff)

(4) Text format

- According to 8-bit ASCII format, one data is transmitted at 11 or 12bytes.

HEADER ('T'/'R')	X Coordinate (4 bytes)	',' (2Ch)	Y Coordinate (4 bytes)	CR (0Dh)	LF (0Ah)*
-----------------------	-----------------------------	-------------	-----------------------------	------------	-------------

* Where "CR" + "LF" was set as a delimiter:

NOTE) The delimiter default is only "CR". Where EEPROM is connected externally, the change to "CR + "LF" can be saved.

- o Example in Continuous Mode:

```
T1234,2345 ← When the touch panel was depressed
T1234,2344
T1234,2344
      :           When the touch panel is continuously depressed
      :
      :
T1234,2344
R1234,2344 ← The touch panel was released.
```

- * The data while the touch panel is being depressed is transmitted with "T" prefixed as a header, and when the touch panel was released, only one data is transmitted with "R" prefixed as a header.
- * The data is the numeral of 0 to 4095 (decimal) for both X and Y.
- * Where the AHL-120N8 and touch panel were connected as specified, the touch panel left lower part becomes the origin.

NOTE) Because of the resistance included in the circuit wiring of the touch panel and the circuit board, the data of (0, 0) is not outputted even when the touch panel left lower part is depressed. Also, even the touch panel right upper part is depressed, the data of (4095, 4095) is not outputted. Actually, 0 to 4095 inside data are outputted. (Example: 50 to 4040)

(5) Response speed

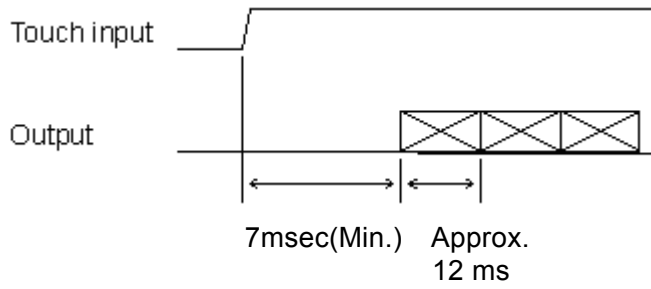

NOTE) The communication speed are as 9600 bps data.

(6) Output rate

- Approx. 87 cps (cps: Co-ordinate Per Second)

NOTE) The communication speed are as 9600 bps data.

(7) Command System

Command	Operation
RE	Resets the AHL-120N8. However, if this command is received during data transmission, the data being transmitted may be in disorder.
DI	Diagnosis of the AHL-120N8. In the normal condition, "Pass ____" is returned. * " " means the space.
SR	Transmission stop. The command is accepted, however. During data transmission, the transmission is stopped from the next data.
BR	Transmission re-start
XOFF	(Same as "SR" command)
XON	(Same as "BR" command)
VE	Returns software version "Vn.nn_". * " " means the space.
LF	The data delimiter should be "CR(0Dh)" + "LF (0Ah)". However, where no EEPROM is connected, the delimiter returns to "CR" if the AHL-120N8 is reset.
CR	The data delimiter should be "CR (0Dh)".
XL	Returns the reference data on the X-coordinate low voltage side. The reference data refers to the data in the touch panel electrode part.
XH	Returns the reference data on X-coordinate high-voltage side.
YL	Returns the reference data on Y-coordinate low-voltage side.
YH	Returns the reference data on Y-coordinate high-voltage side.
SM (MM)	Sets to the Make mode. However, where no EEPROM is connected, the unit returns to the continuous mode if the AHL-120N8 is reset.
MB	Sets to the Make & Break mode. However, where no EEPROM is connected, the unit returns to the continuous mode if the AHL-120N8 is reset.
CM	Sets to the Continuous mode.
T "bb"	Changes the communication speed. However, where no EEPROM is connected, the default is selected if the AHL-120N8 is reset. ^{NOTES)} bb : Communication speed "19" (19200) / "96" (9600) / "48" (4800) / "24" (2400) / "12" (1200)
BZ	Respond Buzzer duration. Relation between responded value and approximate time duration is as follows 0 ...0ms(No sound) 1 ...25ms 2 ...50ms 3 ...75ms 4 ...100ms 5 ...125ms
BZ#	Change Buzzer duration (#=0 - 5). BZ0 ... 0ms (No sound) BZ1 ... About 25ms BZ2 ... About 50ms BZ3 ... About 75ms BZ4 ... About 100ms BZ5 ... About 125ms In case of no EEPROM and after reset of AHL-120N8, initial value returns to BZ4(100ms).
EA	Clear the content of EEPROM and reset. Set the content of EEPROM default values after resetting.

NOTES) (1) Transmit the command in the ASCII format.

(2) When transmitting the command, send "CR" (0Dh) lastly (as a delimiter).

(3) Any letter, capital or small, is effective for the command.

(4) The command is executed immediately upon receipt thereof. The command is accepted even when the AHL-120N8 is being transmitted, and for the command with response data, such as "DI" and "VE" commands, the response data is outputted in the course of position data, and then, the position data is outputted again.

(Example) "DI" command

:
:
:

T0381,0892
 T0381,0892
 T0380,0892
 Pass
 T0380,0893
 T0381,0892
 :
 :

- (5) For the response data to the command, normally, transmit "CR" (0Dh) lastly (as a delimiter).
- (6) Where the command could not be received normally or the command that is not present in the list was sent, it is disregarded. (No data is outputted.)
- (7) The interval between commands should be 15 ms or more. However, it should be more after "RE" command. Therefore, please do an enough test when you transmit the command after "RE".

(8) Output pattern when the transmission stop and transmission restart commands were received

<Pattern 1>

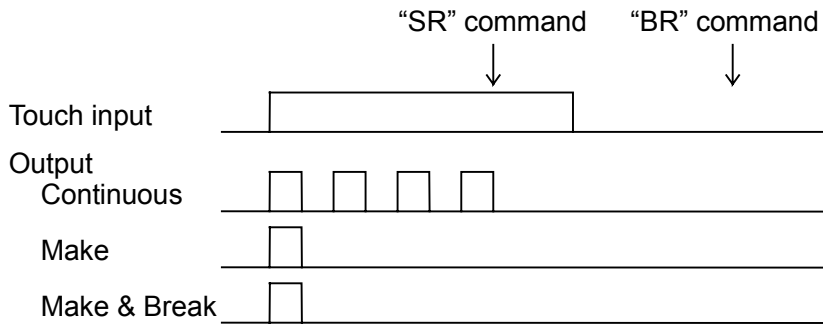

<Pattern 2>

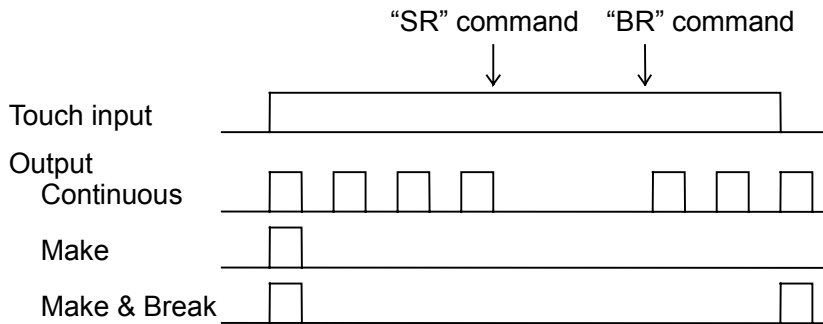

<Pattern 3>

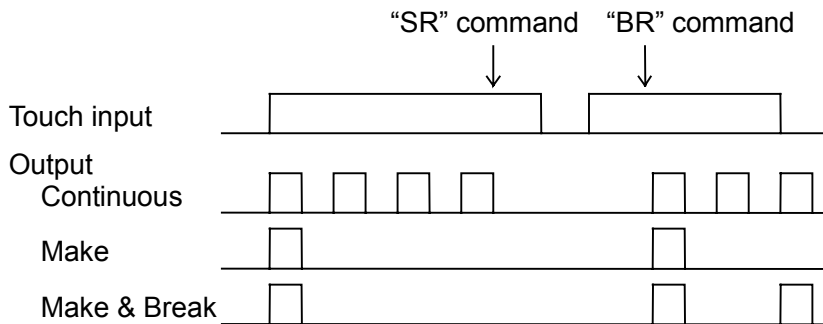

* Each pulse of output is one-point data.

(9)About Plug and Play

AHL-120N8 has a mode which acts as Plug and Play device for Windows.

[Control Panel]-[Add Hardware] or [Device Manager]-[Scan for Hardware Changes] can detect AHL-120N8.

To use as a Plug and Play Device connect Pin CTS(19) to RTS of Host-PC.

11. Other Functions

(1) Reset

AHL-120N8 has the built-in reset function described below. Therefore the reset circuit and the blackout detecting circuit are unnecessary externally.

(a) Power on reset

When a power supply was supplied, power-on reset is carried out.

(b) Brown-out reset

When the supply voltage (VDD) deteriorate about 4.1V during movement, Brown-out reset AHL-120N8 inside. When VDD was as above about 4.1V again, the reset is removed. By this, When a power supply is unstable, Brown-out reset can evade malfunction that can occur.

(2) Buzzer

When touch input was settled, output the pulse of the 'H' level on a BUZ terminal (25 pins). By connecting a buzzer to this terminal, a beep occurs at the time of a touch.

The pulse width (the length of the buzzer) sets it by a BZ# command (in the case of serial interface) in 0 - 125msec.

NOTE) The drive of the buzzer is not possible with a BUZ terminal. Therefore constitute an appropriate drive circuit.

(3) Calibration

(a) Auto calibration

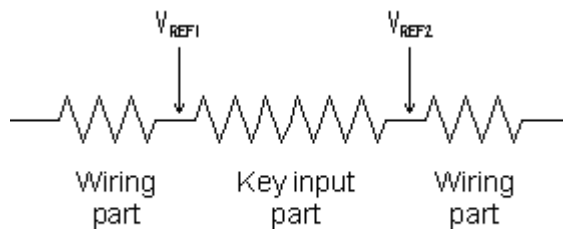

Touch Panel Equivalent Circuit

Since the touch panel forms the equivalent circuit as shown in the figure above, if direct current voltage is applied to both ends of the touch panel, some dc voltage will be applied to the key input part, and the remaining one will be applied to the wiring part. Consequently, if the resistance value of only key input part and only wiring part changes, the voltage applied thereto also changes. In other words, if the resistance value in each part of the touch panel changes, the output voltage when the same point on the touch panel was depressed differs, thereby giving rise to a phenomenon of positional deviation.

On the other hand, in combinations of (AHL-120N8) + (8-wire touch panel), the AHL-120N8 checks double-end voltage (reference voltage: V_{REF1} , V_{REF2}) in the key input part of the touch panel in order to make internal correction so that the data on the low voltage side becomes zero and the high-voltage side data becomes "4095" which is referred to as auto calibration; therefore, there is virtually no positional deviation caused by changes in resistance value in each part of the touch panel.

The reference voltage is saved inside the AHL-120N8.

The AHL-120N8 checks the reference voltage when; 1. the power is turned ON; and 2. the unit is reset.

- * Normally, the touch panel reference data does not change significantly as shown in the example above. Accordingly, the reference data is not rewritten substantially, either.
- * In our touch panel, the resistance value in each part is hard to change, but it may vary, depending on operating conditions (environment) or when it has been used over a long period of time.

(b) User calibration

In the touch panel module in which the touch panel and display were laminated, the touch panel pressing position and display position must be aligned with each other. This is called "user calibration".

This user calibration should be carried out when the touch panel module is used for the first time, and the touch panel pressing position and display position shifted, for example.

NOTE) There is no correlation between the touch panel pressing position and display position with the touch panel module assembled. It is, therefore, necessary to always carry out user calibration the first time the touch panel module is used. Even when the touch panel module is of the same configuration, the position data in the same point of the touch panel differs among the modules for reasons of dispersion in touch panel resistance value, etc. Also, there is a need to carry out user calibration for each module even if the touch panel module is of the same configuration since there is an error in touch panel and display lamination as well, for example.

As one example of user calibration method, a description is given of the method used by pressing 2 points on the touch panel.

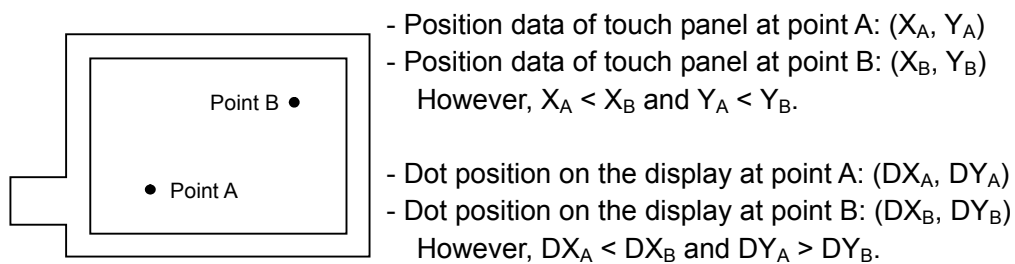

The number of dots (DX1) per data in the X direction is:

$$DX1 = (DXB - DXA) / (XB - XA) \text{_____A)}$$

The number of dots (DY1) per data in the Y direction is:

$$DY1 = (DYA - DYB) / (YB - YA) \text{_____B)}$$

Therefore, the relationship between the optional positions (XD, YD) on the touch panel and dot positions (DXD, DYD) on the display is:

$$DXD = DXA + DX1 \times (XD - XA) \text{_____C)}$$

$$DYD = DYA - DY1 \times (YD - YA) \text{_____D)}$$

Explanation is given below of the above calibration method.

- 1) Press 2 points on the display to obtain the data of XA, YA, XB & YB. Save these data in the host computer.
- 2) From eq. A) and eq. B) above, find DX1 and DY1. Save this data and DXA & DYA as well in the host computer.

This completes the user calibration. During normal operation, find the touch positions DXD, DYD on the display unit from these data and position data XD, YD when the touch panel was depressed, using eq. C) and eq. D) above. This calculation should be made each time the touch panel position data is inputted.

Thus, the touch positions DXD, DYD on the display are found according to the touch panel position data XD, YD.

12. Outline Drawing

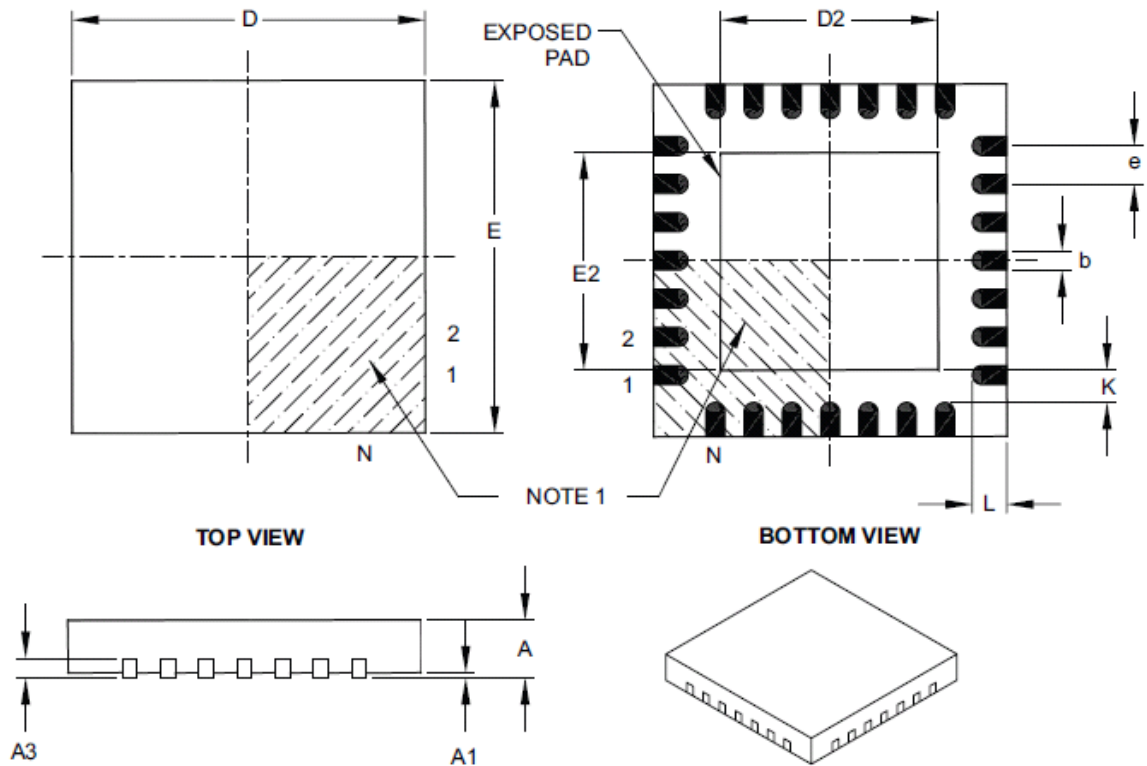

Dimension Limits	Units	MILLIMETERS		
		MIN	NOM	MAX
Number of Pins	N	28		
Pitch	e	0.65 BSC		
Overall Height	A	0.80	0.90	1.00
Standoff	A1	0.00	0.02	0.05
Contact Thickness	A3	0.20 REF		
Overall Width	E	6.00 BSC		
Exposed Pad Width	E2	3.65	3.70	4.20
Overall Length	D	6.00 BSC		
Exposed Pad Length	D2	3.65	3.70	4.20
Contact Width	b	0.23	0.30	0.35
Contact Length	L	0.50	0.55	0.70
Contact-to-Exposed Pad	K	0.20	-	-

13. Peripheral Circuit Example

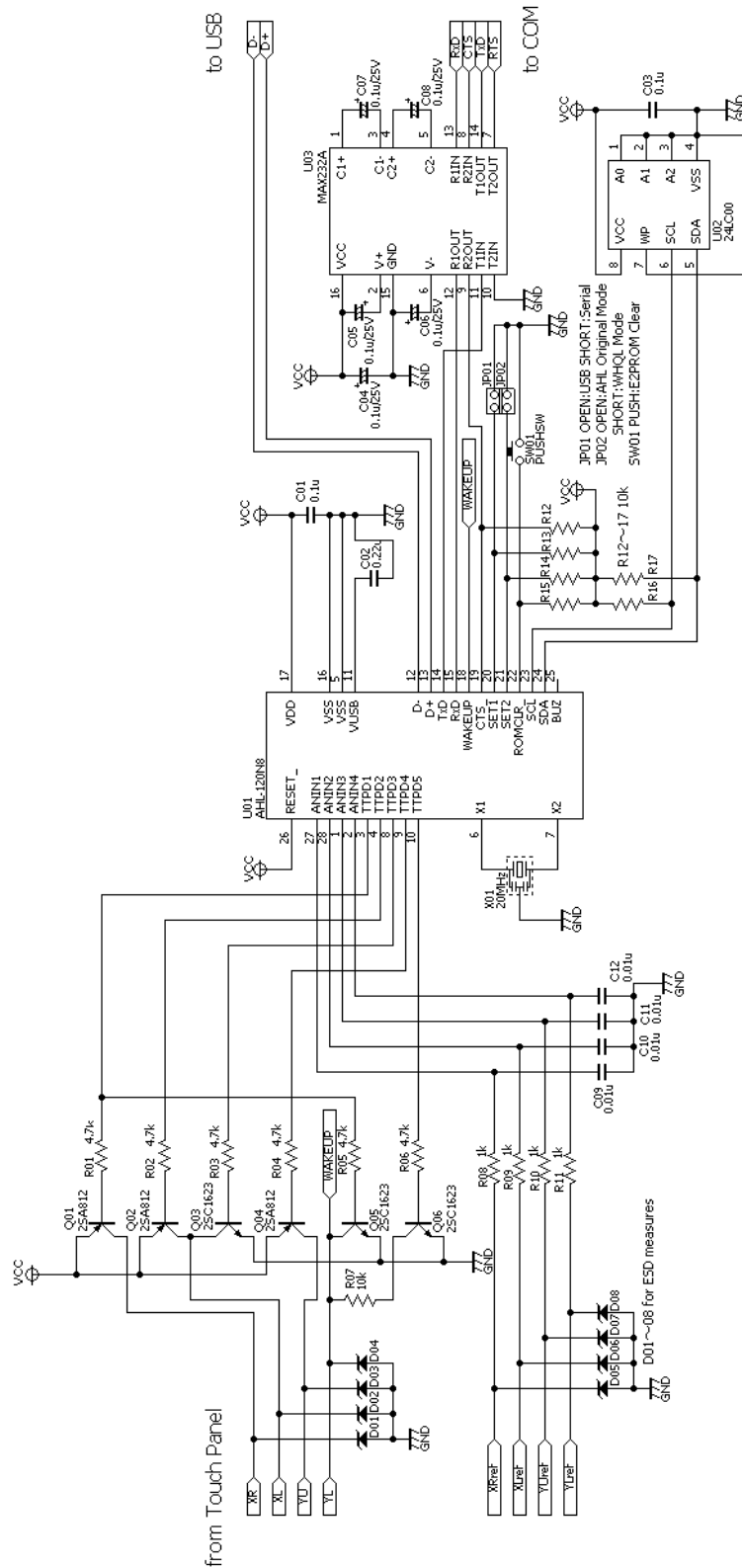

14. Mounting Conditions

The profile of the reflow soldering of AHL-120N8 is based on J-STD-020C of the JEDEC standard.

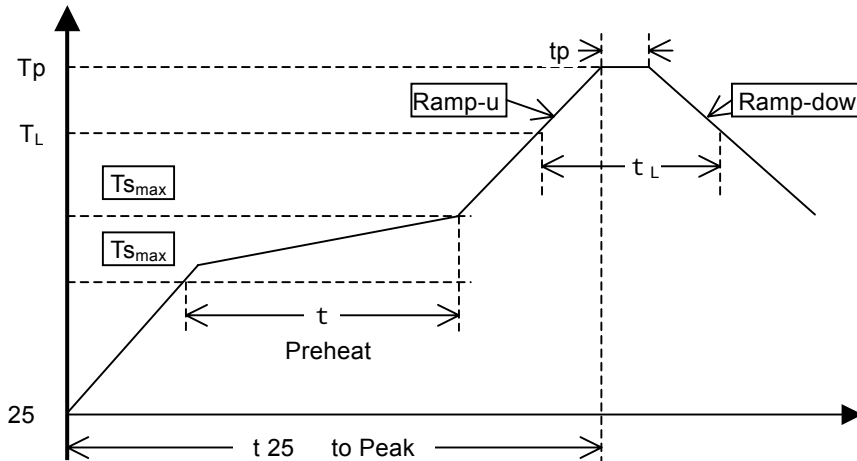

Profile Feature	Sn-Pb Eutectic Assembly	Pb-Free Assembly
Average Ramp-Up Rate (T _{smax} to T _p)	3 /second max.	3 /second max.
Preheat		
- Temperature Min(T _{smin})	100	150
- Temperature Max(T _{smax})	150	200
- Time (T _{smin} to T _{smax})	60-150 seconds	60-180 seconds
Time maintained above:		
- Temperature(T _L)	183	217
- Time(t _L)	60-150 seconds	60-150 seconds
Peak/Classification Temperature(T _p)	240 +0/-5	260 +0
Time within 5 of actual Peak Temperature (t _p)	10-30 seconds	20-40 seconds
Ramp-Down Rate	6 /second max.	6 /second max.
Time 25 to Peak Temperature	6 minutes max.	8 minutes max.

15. Operating Precautions

- (1) The AHL-120N8 may produce a latch-up phenomenon where higher voltage than VCC and lower voltage than VSS were applied or voltage exceeding the rating was applied between VCC and VSS. If there arises this latch-up, supply current will significantly increase, leading to thermal breakdown of the element from time to time; it is, therefore, necessary to take utmost care so that the maximum rating is not exceeded during operation.
- (2) The operation guarantee range of VCC supply voltage is as specified. Even within this range, however, if there are sudden fluctuations in supply voltage, malfunctions may arise; it is, therefore, necessary to make arrangements so that supply voltage becomes as stable as possible. It is recommended that as a reference for stabilization, VCC ripple fluctuations (P-P value) at commercial frequency (50 to 60Hz) should be controlled to 10% Max. of the standard VCC value and the transient regulation should be controlled to 0.1 V/ms Max. in momentary changes, for example when the power supply is switched.
- (3) When designing the peripheral circuit, make the wiring from the touch panel to the AHL-120N8 as short as possible. Also, do not provide any parts and wiring that may generate noise near this line. Since this line is an analog line, the AHL-120N8 may misjudge touch panel ON/OFF and fail to detect the accurate pressing position when the touch panel was depressed if the wiring becomes longer and it is affected by noise.
- (4) Avoid using the unit in the environment such that there arises dew condensation.
- (5) When handling the AHL-120N8, give special care to static electricity, and provide satisfactory grounding for the operator and work site; otherwise, the AHL-120N8 may be broken.
- (6) The use of this unit exceeding the specified operating voltage and operating temperature may cause failure. Always use the unit within the specifications.
- (7) Store the AHL-120N8 within the temperature and humidity prescribed in the specifications. Do not store the AHL-120N8 in the atmosphere of organic solvent and acid.

16. Warranty Period and Warranty Range

(1) Warranty period

The warranty period should be one (1) year after the date of delivery.

(2) Warranty range

In the warranty period, if there arises failure or damage due to our nonconformity, our company is ready to repair or replace the defectives. However, in the following cases, the defectives are excluded from the warranty range.

- (a) Failure and damage caused by your mishandling, such as fall and shocks during transportation (movement) after delivery
- (b) Failure and damage caused by disasters and accidents
- (c) Repair & remodeling at other than our company
- (d) Failure and damage caused by handling that runs counter to the usage and precautions described in this specification

NOTE) Only the delivered product should be guaranteed, and any damage induced due to delivered product failure, repair and replacement on work site should be out of the warranty range.

17. Appendix

Difference between 4- and 8-wire touch panels

(a) 4-wire touch panel

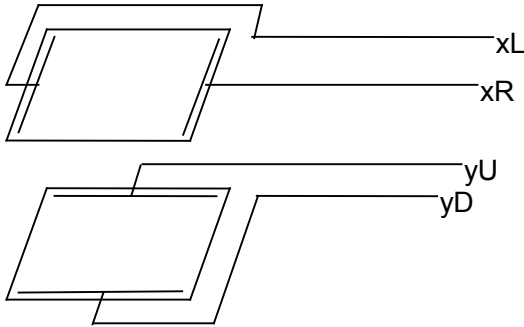

The analog voltage value (position data) in the pressing position is converted to the digital value as it is for output.

Example) When 5 V DC is applied to the touch panel and the analog voltage value in the pressing position is

2 V;

$$2(V) / 5(V) \times 4095 = 1636$$

Thus, "1636" is outputted.

(b) 8-wire touch panel

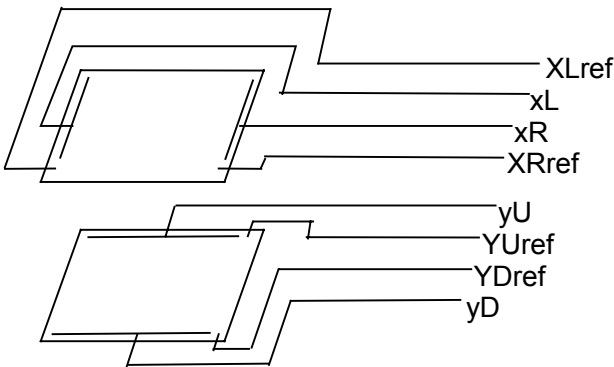

Read the touch panel reference voltage (xRref, xLref, yUref, yDref) and correct the analog voltage value in the pressing position (position data) so that xLref = 0, xRref = 4095, yDref = 0 and yUref = 4095 for output.

Example) When the analog voltage value in the pressing position is 2 V with 5 V DC applied to the touch panel and the reference voltage (for example, xLref, xRref) is 80 and 4,000 respectively: (12-bit resolution)

$$2(V) / 5(V) \times 4095 = 1636$$

$$(1636 - 80) / (4000 - 80) \times 4095 = 1625$$

Thus, "1625" is outputted.

* For details, refer to "11. Other Functions - (3) Calibration - (a) Auto Calibration".